

Tools for mesenchymal stem cell culture

PromoCell®

Solutions for world-class
stem cell research

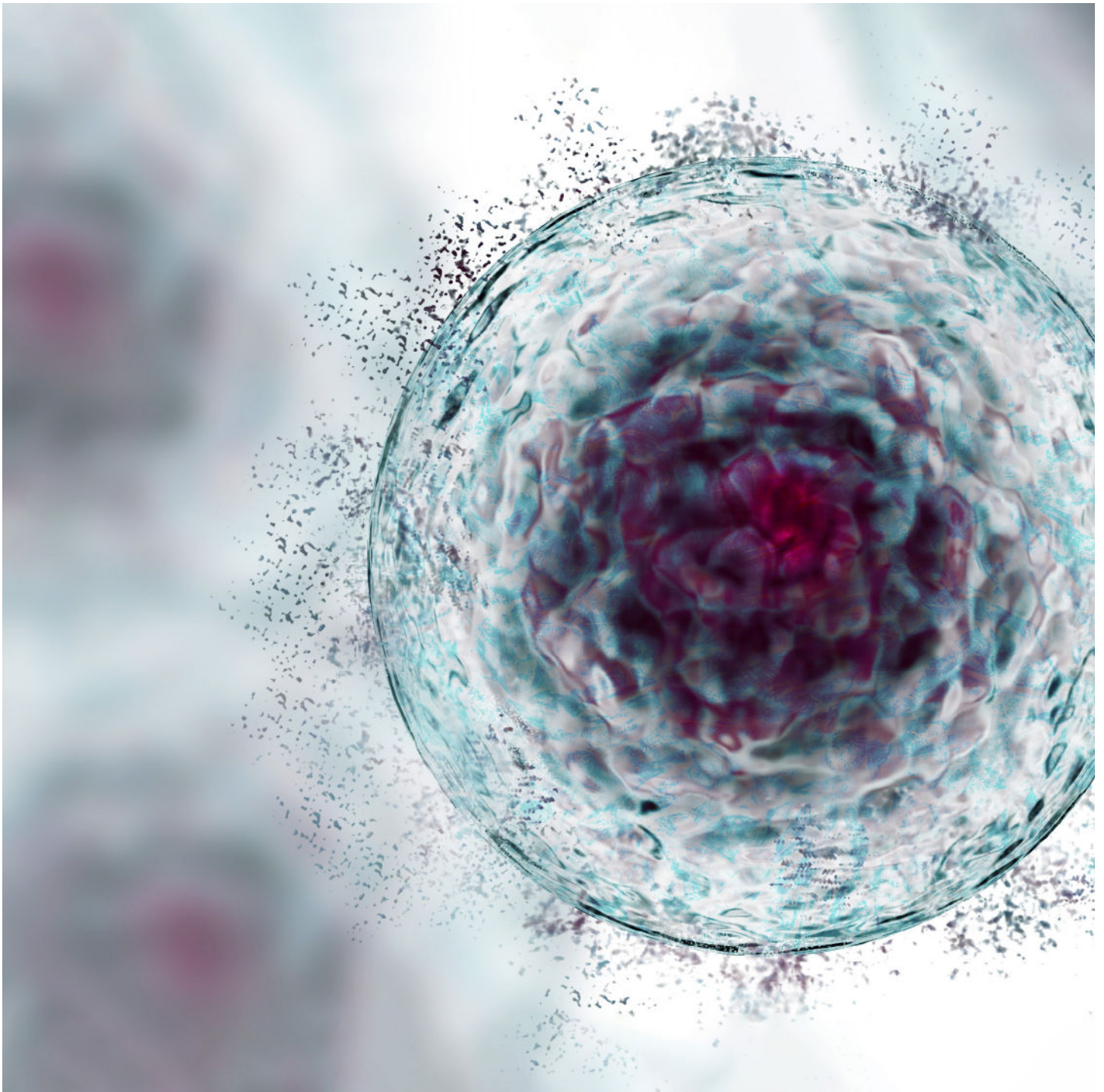

Human Mesenchymal Stem Cells

Mesenchymal stem cells (MSCs) are multipotent cells that can self-renew and differentiate into various cell types. Under appropriate conditions (e.g., appropriate cell growth media and presence of growth factors and differentiation-inducing factors), MSCs can differentiate *in vitro* and *in vivo* into adipocytes, chondrocytes, osteoblasts, myocytes, neurons, hepatocytes, and pancreatic islet cells. In addition to their high differentiation potential, MSCs have immunomodulatory properties, which make them an attractive

tool for cell and gene therapies. Compared with other types of stem cells, MSCs isolated from adult donors are relatively easy to culture and expand, given that an optimized culture medium is used. Therefore, MSCs are the most used cells in regenerative medicine. In addition to their use in research focused on understanding the mechanisms regulating organismal development, cell differentiation, and regeneration, MSCs have become a powerful tool for the development of cell-based therapies for various diseases, including cancer

and degenerative conditions. To help you advance your stem cell research, we offer human MSCs (hMSCs) harvested from different tissues of donors and support the advanced development and manufacturing of cell and gene therapies. Our optimized cell culture media ensure that hMSCs have all the nutrients and factors they need to grow, self-renew, expand, and differentiate into adipocytes, chondrocytes, or osteoblasts.

MSC sources

Stem cells are often poorly characterized, and their use requires time-consuming and standardized protocols. To support the translation

of cellular therapies, the International Society for Cell and Gene Therapy (ISCT) has described three key characteristics of MSCs:

1 Adherence to plastic

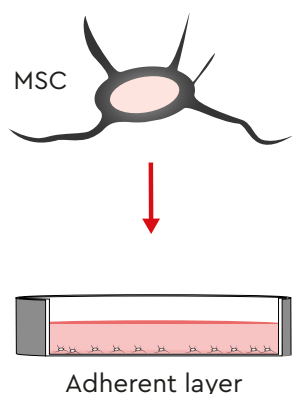

MSCs must adhere to plastic to grow under standard culture conditions

2 Marker expression

Positive ≥ 95% +	Negative ≤ 2% +
<ul style="list-style-type: none"> ■ CD105⁺ ■ CD73⁺ ■ CD90⁺ 	<ul style="list-style-type: none"> ■ CD45⁻ ■ CD34⁻ ■ CD14⁻ or CD11b⁻ ■ CD79α⁻ or CD19⁻ ■ HLA-DR⁻

MSCs are characterized by the presence or absence of specific surface markers

3 Multipotent differentiation potential

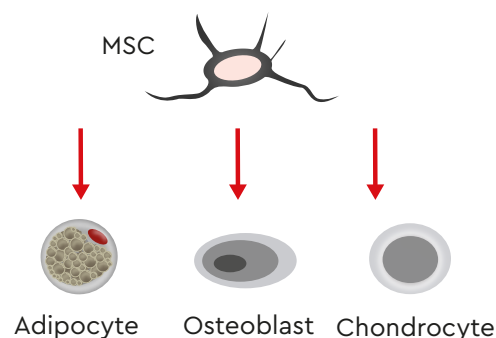

MSCs are multipotent and can differentiate into various cell lineages

We harvest our high-quality hMSCs from the adipose tissue, bone marrow, and umbilical cord matrix (Wharton's jelly) of healthy donors. Our hMSCs are tested for

their ability to differentiate into adipocytes, chondrocytes, and osteoblasts *in vitro*. We help you save time and resources by providing well-characterized hMSCs with verified

expression of MSC markers. Find out about all the key advantages of our MSC cultures down below:

Key advantages of our MSC cultures:

- MSCs with verified expression of surface markers that meet the ISCT criteria
- Standardized and well-characterized MSCs for reproducible research
- Possibility of large-scale production of various types of hMSCs isolated using ISCT standards
- Confirmed differentiation into osteoblasts, adipocytes, and chondrocytes
- Culture in our optimized MSC medium ensures expression of trilineage surface markers
- Custom MSC media according to your needs and regulatory requirements
- GMP-compliant manufacturing of MSC media



Bone marrow

Human Mesenchymal Stem Cells from Bone Marrow (hMSC-BM)

Cat. No. C-12974
cryopreserved cells

Cat. No. C-12975
proliferating cells

Cat. No. C-14090
cell pellet



Umbilical cord

Human Mesenchymal Stem Cells from Umbilical Cord Matrix (hMSC-UC)

Cat. No. C-12971
cryopreserved cells

Cat. No. C-12972
proliferating cells

Cat. No. C-14091
cell pellet

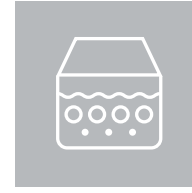

Adipose tissue

Human Mesenchymal Stem Cells from Adipose Tissue (hMSC-AT)

Cat. No. C-12977
cryopreserved cells

Cat. No. C-12978
proliferating cells

Cat. No. C-14092
cell pellet

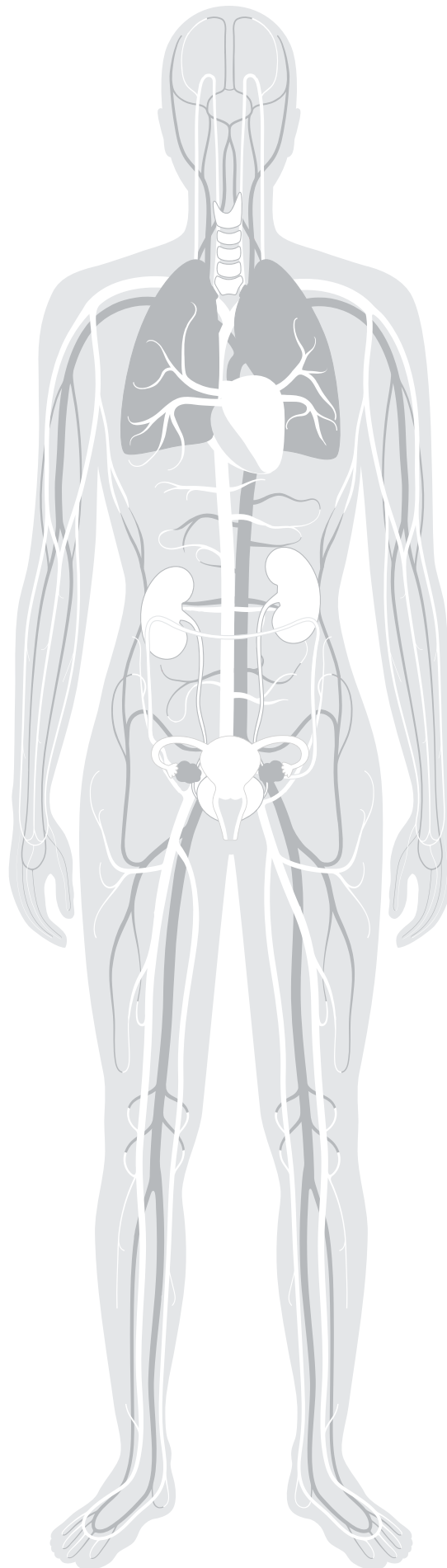

Positive $\geq 95\%$ +	Negative $\leq 2\%$ +
<ul style="list-style-type: none"> ■ CD105⁺ ■ CD73⁺ ■ CD90⁺ 	<ul style="list-style-type: none"> ■ CD45⁻ ■ CD34⁻ ■ CD14⁻ or CD11b⁻ ■ CD79α⁻ or CD19⁻ ■ HLA-DR⁻

MSC marker expression

According to the International Society for Cellular Therapies (ISCT) guidelines. Each lot is tested for its ability to differentiate *in vitro* into adipocytes, chondrocytes, and osteoblasts.

MSC expansion media

Our optimized growth media enable consistent growth and trilineage differentiation potential of hMSCs. Our media contain all

the growth factors and supplements necessary for the robust expansion and generation of high-quality multipotent cells.

MSC Growth Medium 2



Our MSC Growth Medium 2 (C-28009) is an optimized low-serum medium for routine culture of hMSC.

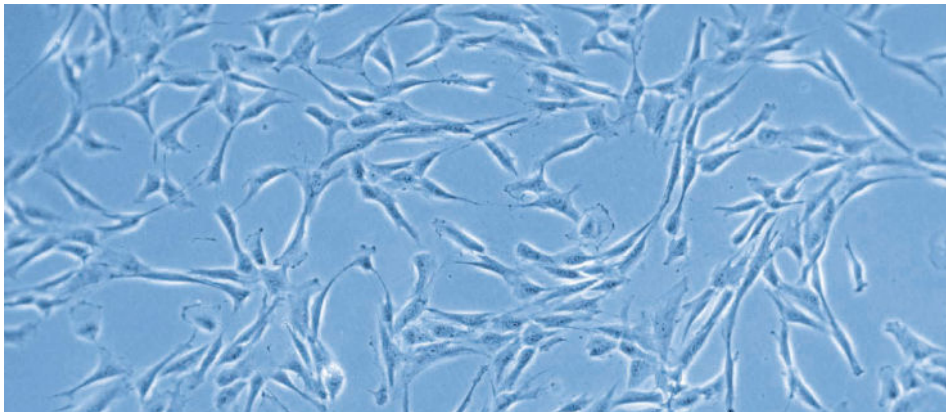

Fig. 1: Phase-contrast image of hMSCs isolated from bone marrow and cultured in MSC Growth Medium 2.

MSC Growth Medium XF



Our MSC Growth Medium XF (C-28019) and MSC Growth Medium XF, phenol red-free (C-28018) are serum-free and xeno-free culture media. They are ideal for the

standardized expansion and culture of hMSCs from the bone marrow, umbilical cord, and adipose tissue in fibronectin- or vitronectin-coated plates.

A

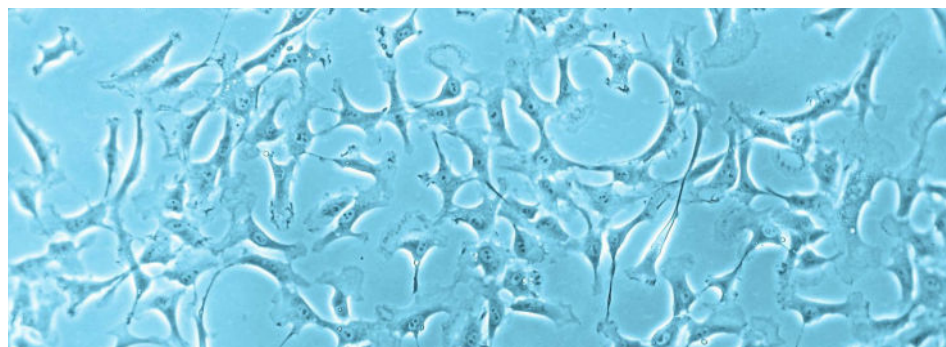

B

MSC Growth Medium XF



Cumulative population doublings

Population doubling time [h]

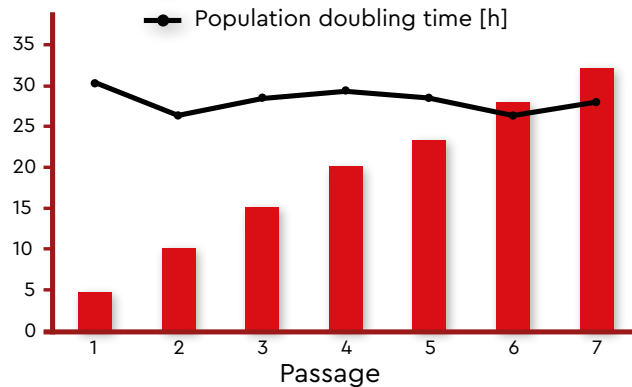

Fig. 2: Growth of bone marrow-derived hMSCs (hMSC-BM) in MSC Growth Medium XF. A: Phase-contrast image of MSCs cultured in xeno-free MSC Growth Medium XF. B: Cumulative population doubling and doubling times of hMSCs over the course of 7 passages. Culturing in MSC Growth Medium XF enables a stable growth rate of less than 30 h/doubling even after prolonged in vitro culture (32 population doublings over the course of 7 passages).

MSC cryopreservation



Our Cryo-SFM is a defined, animal component-free, and protein-free cryopreservation medium. Our optimized and ready-to-use formulation is based on methylcellulose, DMSO, and other cryoprotectants recommended for

the standardized cryopreservation of MSCs. Freezing primary human cells and stem cells in Cryo-SFM under standard freezing conditions ensures excellent viability, attachment, and growth performance after thawing.

MSC differentiation medium

We offer five MSC differentiation media that induce differentiation of MSCs into adipogenic, chondrogenic, osteogenic, or neurogenic lineages. The differentiation media have been designed for usage with our own

cryopreserved Mesenchymal Stem Cells. In combination with our optimized growth media the differentiation media provide a complete and convenient workflow for the standardized induction of terminal differentiation.

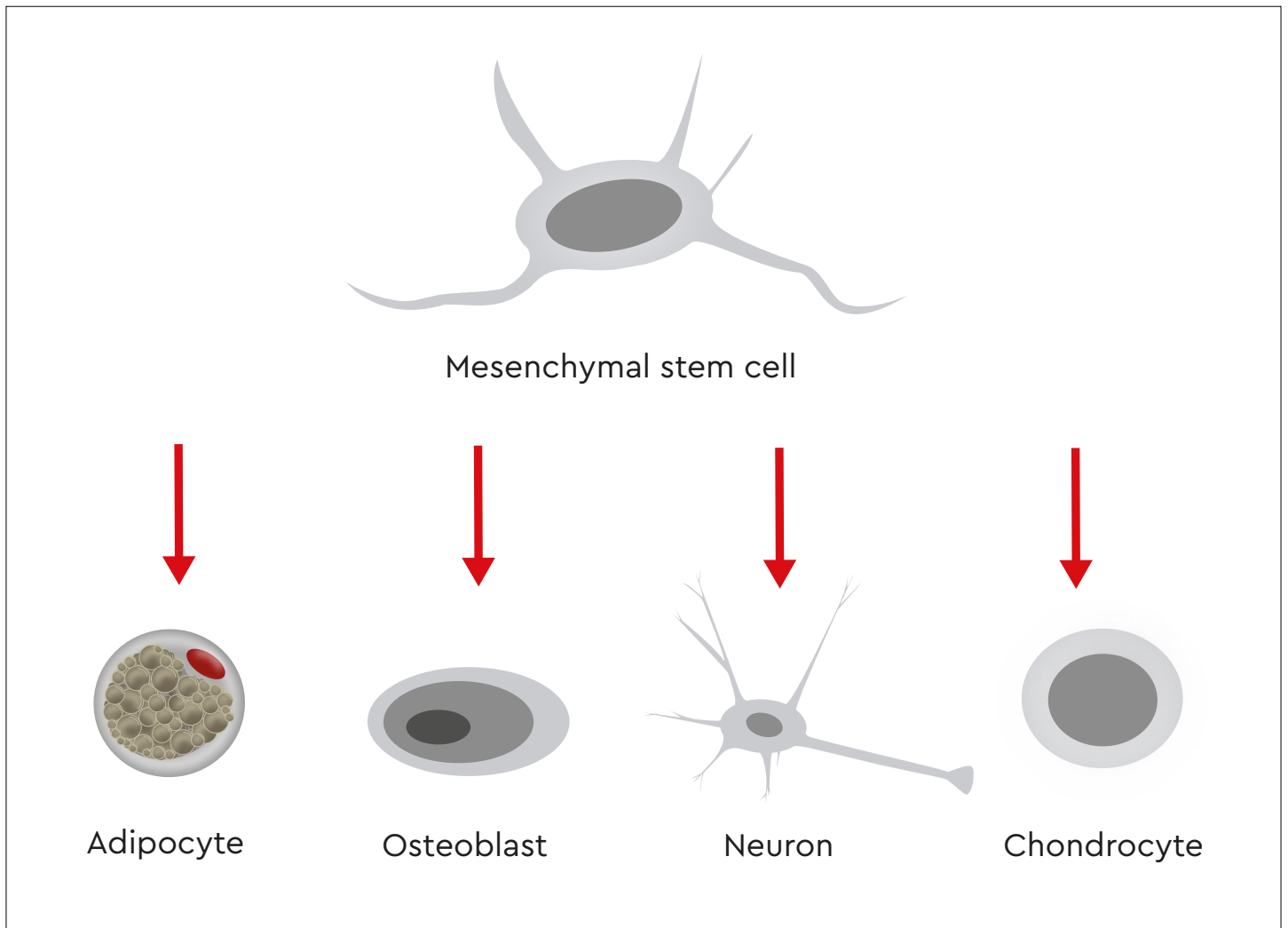

Variations in cell culture conditions can lead to inefficient differentiation of hMSCs into adipocytes, chondrocytes, or osteocytes. Our optimized MSC Differentiation Media enables you to generate different types of differentiated human cells from hMSCs.

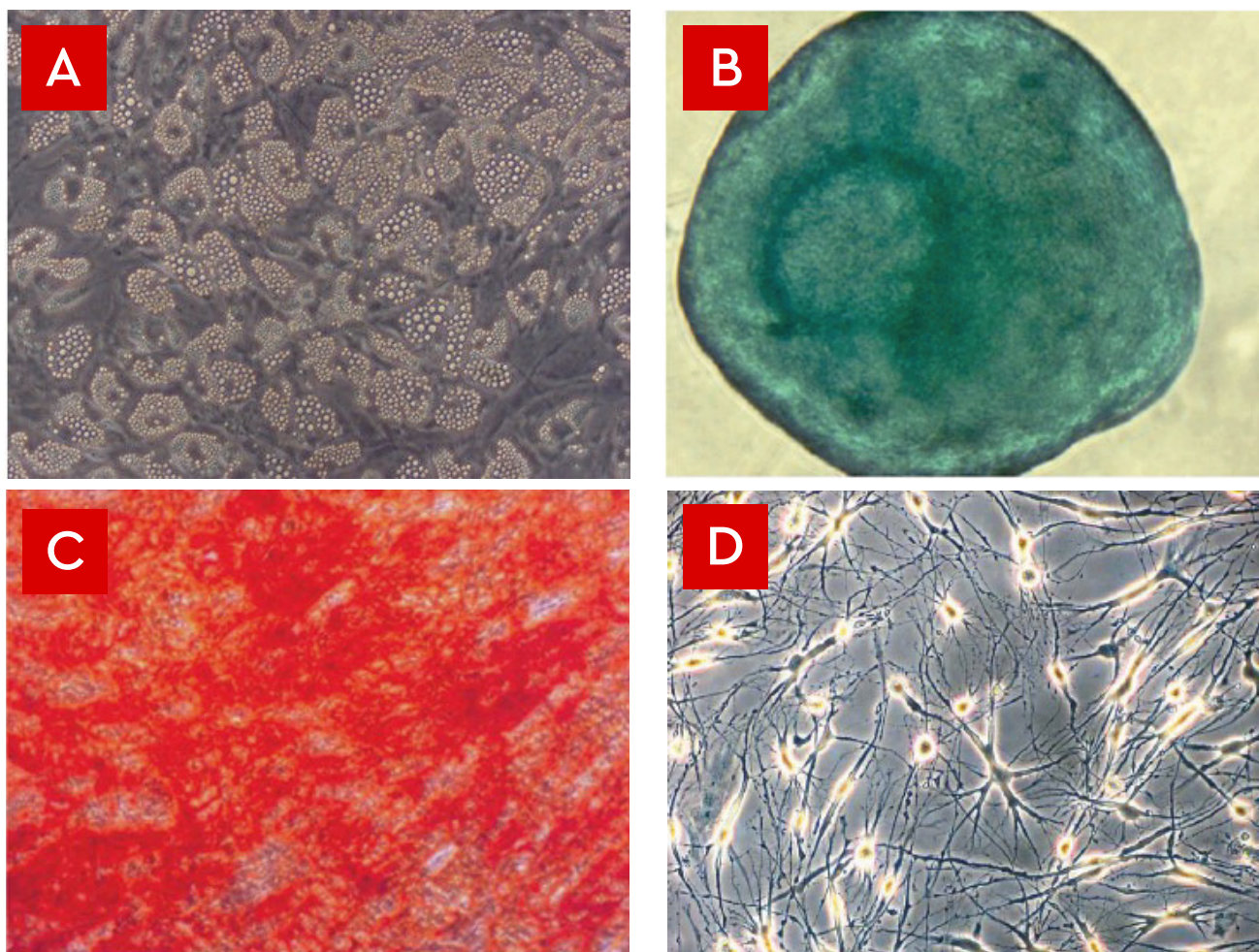

Fig. 3: In vitro differentiation of hMSCs into adipocytes, chondrocytes, osteoblasts, and neuronal cells. **A:** Accumulation of lipid vesicles in adipocytes differentiated from bone marrow-derived hMSCs. The cells show typical characteristics of mature adipocytes, including intracellular lipid vacuoles. **B:** Alcian blue staining of cartilage spheroids after in vitro differentiation of hMSCs. Alcian blue stains cartilage extracellular matrix. **C:** Alizarin Red S staining of mature osteoblasts after in vitro differentiation of bone marrow-derived hMSCs. Alizarin Red S stains extracellular calcium deposits. **D:** Representative image of neurons after in vitro differentiation of bone marrow-derived hMSCs into neurogenic lineages.

Visit our website to read our detailed step-by-step protocols together with instructions on how to detect successful differentiation:
promocell.com/scientific-resources/application-notes

MSC media for cell & gene therapy

Because of the many advantages of MSC-based therapies compared with conventional pharmacotherapies, MSCs have become a powerful tool for the development of cell-based therapies for various diseases, including cancer and degenerative conditions. Regenerative medicine involves the use of therapeutics to repair tissue damage, restore degenerative tissues, promote wound healing, and replace dysfunctional tissues and organs. MSCs have high regenerative potential and have been used to regenerate bone, muscles, nerves, myocardium, liver, cornea, trachea, heart, and skin. A key challenge in cell therapies is that many cells is required to achieve a clinically significant therapeutic effect. MSC are easy to isolate from a wide variety of tissues, including the bone marrow, umbilical cord matrix, adipose tissue, tendons, lungs,

and periosteum. MSCs can be expanded *in vitro*, given that an optimized culture medium is used; however, expanding MSCs in a standardized and well-characterized way can be challenging. MSCs are multipotent, versatile, and can differentiate into multiple cell types. Therefore, they can be used to replace various malfunctioning or degenerated tissues in the human body. Another advantage of MSCs as therapeutic products is that they are immune-privileged and are, therefore, able to escape immunological destruction. The immunomodulatory properties of MSCs make MSC-based therapies a promising treatment option for autoimmune, inflammatory, and hematologic diseases. MSCs can successfully migrate to tumors *in vivo*; therefore, they can be used to deliver anticancer drugs and tumor suppressor genes to tumor sites. The immunomodulatory

properties of MSCs can be leveraged to modulate the tumor microenvironment and suppress tumor progression. MSCs can be engineered to activate immune cells, including macrophages, dendritic cells, and T cells. Collectively, these immune cells can eliminate cancer cells in primary tumors and metastatic sites. The ability of MSCs to migrate to tumor sites and activate immune cells provides an opportunity to combine them with CAR-T cells to enhance the function of engineered antitumor T cells. As with all therapeutic products developed for clinical applications, the safety of MSC therapies must be guaranteed. We manufacture our serum-free, xeno-free MSC culture medium using the highest-quality reagents and supplements, following all Good Manufacturing Practice (GMP) guidelines and international regulatory standards.

PromoExQ MSC Growth Medium XF



Our PromoExQ MSC Growth Medium XF (EQ-C-28019) is optimized for the long-term expansion of human MSCs. Consisting of PromoExQ MSC Basal Medium XF and SupplementMix PromoExQ MSC XF, our ready-to-use PromoExQ MSC Growth Medium XF has all the necessary components for consistent growth and maintenance of MSCs. This medium is ideal for the culture of various multipotent MSCs, including MSCs from the bone marrow, umbilical cord matrix (Wharton's jelly), and adipose tissue.

Our PromoExQ MSC Growth Medium XF is produced in accordance with the EXCiPACT™ GMP certification scheme and comes with relevant support documentation, allowing you to grow and expand human MSCs in a GMP-compliant

environment. Building on our existing ISO 9001:2015 quality management system, the EXCiPACT™ GMP certification standard supports the manufacturing of pharmaceutical excipients and is fully aligned with the American National Standard for Good Manufacturing Practices according to NSF/IPEC/ANSI 363.

To help you streamline the transition of your human MSC culture from research to GMP-compliant expansion for therapeutic applications, we also provide a research-grade version of our PromoExQ MSC Growth Medium XF. The release specifications of the functional performance assays of the research-grade medium are identical to those of the GMP-grade cell culture medium.

High-quality large-scale MSC lots

The commercial and clinical translation of cell-based therapies requires large-scale production of homogeneous and well-characterized MSC populations. Our expertise in cell isolation, media manufacturing, and quality control enables

us to offer high-quality, large-scale MSC cultures to help you advance cell-based therapies. The use of large MSC lot sizes also minimizes donor- and source-dependent effects on cell characteristics.

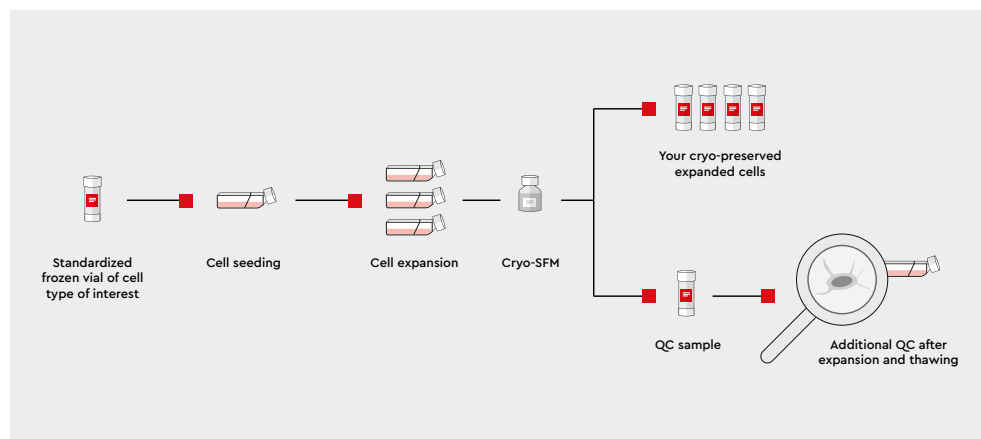

What we offer:

- **Customized large-scale industrial lots** of standardized MSCs from bone marrow and adipose tissue
- **Guaranteed MSC functionality and phenotypes** in accordance with ISCT guidelines
- **Optimized media** with supplements
- **Expert technical support**

Our solutions help you avoid time-consuming cell isolation and testing processes, as well as lot-to-lot variation problems.

Contact our experienced scientists to answer your questions and help you choose the right products: [promocell.com/about-us/contact](https://www.promocell.com/about-us/contact)

GMP-compliant MSC culture

Using high-quality cell culture media and reagents that comply with international regulatory guidelines is critical to ensure a seamless transition from bench to clinic. The EXCiPACT™ GMP standard for pharmaceutical excipients enables us to serve the growing demand of researchers working with our cell culture media and reagents in a regulated environment. Our product development

pipeline is designed to ensure compliance with all relevant regulatory guidelines. By streamlining documentation of all raw materials, we reduce your regulatory burden, cost, and time. In addition, our manufacturing process enables us to offer customized products to meet your needs during product development and manufacturing.

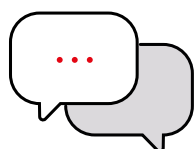

1

Contact us to discuss your questions & regulatory requirements

Personalized consultation to define the basic requirements of your project.

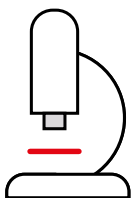

2

Evaluation of the best product for your project

During the first phase we support you in finding the best product tailored to your needs.



3

Customer Requirement Document Process (CRD Process)

Our customer requirement document process (CRD) supports you in identifying, determining and communicating your regulatory requirements. This process allows us to customize our products and documentation according to your needs, saving you significant time and effort.



4

Implementation of the product with our GMP-Service – what we offer:

- Documentation required for supporting your risk assessment
- Full traceability and raw material control
- Ensured lot-to-lot consistency using comprehensive quality control tests for composition, sterility, and biological activity
- Extended quality tests or documentation (e.g. endotoxin, osmolality) not covered in our standard quality control
- Custom media formulations and production processes to fulfil your raw material specifications and regulatory documentation requirements
- Upscaling and custom media bag production (e.g., 2L, 5L, 10L, 20L)
- Dedicated scientific and technical support

Our commitment to quality

Ethics and quality are at the heart of our business. We own the entire tissue collection and manufacturing process, which means that we can provide fast and direct ethical regulatory support. All our products comply with European biomedical conventions,

ensuring that human rights and donor privacy are always protected. Our ISO certifications demonstrate our commitment to quality, and our EXCiPACT™ GMP certification enables us to produce our cell culture media and reagents according to GMP standards. Each

year, 600 peer-reviewed publications feature PromoCell products. We operate in over 40 countries around the world, helping scientists with their research needs—we help your science move the world forward.



- Our Quality Management System is certified according the EXCiPACT™ GMP standard



- PromoCell operates according to ISO 9001:2015 in order to consistently provide products and services that meet customer requirements as well as applicable statutory and regulatory requirements.



For more information access: www.promocell.com/compliance





Our tools for stem cell culture

Human stem cells and progenitor cells

Cell type	Description	Catalog no.	Marker	Recommended
Human Mesenchymal Stem Cells (hMSC)	Human Mesenchymal Stem Cells from Bone Marrow (hMSC-BM)	C-12974	CD105 ⁺ /CD73 ⁺ /CD90 ⁺ and CD45 ⁻ /CD34 ⁻ /CD14 ⁻ /CD19 ⁻ /HLA-DR ⁻	C-28009 C-28019 EQ-C-28019 C-28018
	Human Mesenchymal Stem Cells from Umbilical Cord Matrix (hMSC-UC)	C-12971	CD105 ⁺ /CD73 ⁺ /CD90 ⁺ and CD45 ⁻ /CD34 ⁻ /CD14 ⁻ /CD19 ⁻ /HLA-DR ⁻	C-28009 C-28019 EQ-C-28019 C-28018
	Human Mesenchymal Stem Cells from Adipose Tissue (hMSC-AT)	C-12977	CD105 ⁺ /CD73 ⁺ /CD90 ⁺ and CD45 ⁻ /CD34 ⁻ /CD14 ⁻ /CD19 ⁻ /HLA-DR ⁻	C-28009 C-28019 EQ-C-28019 C-28018
hCD34 ⁺ -CB	Human CD34 ⁺ Progenitor Cells from Cord Blood	C-12921	CD34 ⁺	C-28021 C-39891
hPC-PL	Human Pericytes from Placenta	C-12980	CD105 ⁺ /CD146 ⁺ and CD31 ⁻ /CD34 ⁻	C-28041

Cell culture media for expansion and differentiation

Cell type	Product	Size	Catalog number
Human Mesenchymal Stem Cells (hMSC)	Mesenchymal Stem Cell Growth Medium 2 (Ready-to-use)	500 ml	C-28009
	Mesenchymal Stem Cell Growth Medium XF (Ready-to-use) 5	500 ml	C-28019
	PromoExQMSC Growth Medium XF	500 ml	EQ-C-28019
	Mesenchymal Stem Cell Growth Medium XF (Ready-to-use), phenol red-free	500 ml	C-28018
	Mesenchymal Stem Cell Adipogenic Differentiation Medium 2 (Ready-to-use)	100 ml	C-28016
	Mesenchymal Stem Cell Chondrogenic Differentiation Medium (Ready-to-use)	100 ml	C-28012
	Mesenchymal Stem Cell Osteogenic Differentiation Medium (Ready-to-use)	100 ml	C-28013
	Mesenchymal Stem Cell Chondrogenic Differentiation Medium without Inducers (Ready-to-use)	100 ml	C-28014
	Mesenchymal Stem Cell Neurogenic Differentiation Medium (Ready-to-use)	100 ml	C-28015
hCD34 ⁺ -CB	Hematopoietic Progenitor Expansion Medium XF	500 ml	C-28021
	Cytokine Mix E for 100 ml HPC Expansion Medium XF	1 ml	C-39890
	Cytokine Mix E for 500 ml HPC Expansion Medium XF	5 ml	C-39891
hPC-PL	Pericyte Growth Medium 2 (Ready-to-use)	500 ml	C-28041

Reagents for cell dissociation and cryopreservation

Product	Size	Catalog number
DetachKit	30 ml	C-41200
	125 ml	C-41210
	250 ml	C-41220
Accutase-Solution	100 ml	C-41310
Cryo-SFM	30 ml	C-29910
	125 ml	C-29912

References

1. Almeida-Porada G, Atala AJ, Porada CD. Therapeutic Mesenchymal Stromal Cells for Immunotherapy and for Gene and Drug Delivery. *Mol Ther Methods Clin Dev.* 2020;16:204–224.
2. Aravindhan S, Ejam SS, Lafta MH, Markov A, Yumashev AV, Ahmadi M. Mesenchymal stem cells and cancer therapy: insights into targeting the tumour vasculature. *Cancer Cell Int.* 2021;21(1):158.
3. Chan LY, Dass SA, Tye GJ, Imran SAM, Wan Kamarul Zaman WS, Nordin F. CAR-T Cells/-NK Cells in Cancer Immunotherapy and the Potential of MSC to Enhance Its Efficacy: A Review. *Biomedicines.* 2022;10(4):804.
4. Costela-Ruiz VJ, Melguizo-Rodríguez L, Bellotti C, et al. Different Sources of Mesenchymal Stem Cells for Tissue Regeneration: A Guide to Identifying the Most Favorable One in Orthopedics and Dentistry Applications. *Int J Mol Sci.* 2022;23(11):6356.
5. Crisan M, Yap S, Casteilla L, et al. A perivascular origin for mesenchymal stem cells in multiple human organs. *Cell Stem Cell.* 2008;3(3):301–313.
6. da Silva Meirelles L, Caplan AI, Nardi NB. In search of the *in vivo* identity of mesenchymal stem cells. *Stem Cells.* 2008;26(9):2287–2299.
7. Dominici M, Le Blanc K, Mueller I, et al. Minimal criteria for defining multipotent mesenchymal stromal cells. The International Society for Cellular Therapy position statement. *Cytotherapy.* 2006;8(4):315–317.
8. Hombach AA, Geumann U, Günther C, Hermann FG, Abken H. IL7-IL12 Engineered Mesenchymal Stem Cells (MSCs) Improve A CAR T Cell Attack Against Colorectal Cancer Cells. *Cells.* 2020;9(4):873.
9. Law S, Chaudhuri S. Mesenchymal stem cell and regenerative medicine: regeneration versus immunomodulatory challenges. *Am J Stem Cells.* 2013;2(1):22–38.
10. Musiał-Wysocka A, Kot M, Majka M. The Pros and Cons of Mesenchymal Stem Cell-Based Therapies. *Cell Transplant.* 2019;28(7):801–812.
11. Renesme L, Pierro M, Cobey KD, et al. Definition and Characteristics of Mesenchymal Stromal Cells in Preclinical and Clinical Studies: A Scoping Review. *Stem Cells Transl Med.* 2022;11(1):44–54.
12. Rivera-Cruz CM, Shearer JJ, Figueiredo Neto M, Figueiredo ML. The Immunomodulatory Effects of Mesenchymal Stem Cell Polarization within the Tumor Microenvironment Niche. *Stem Cells Int.* 2017;2017:4015039.
13. Song N, Scholtemeijer M, Shah K. Mesenchymal Stem Cell Immunomodulation: Mechanisms and Therapeutic Potential. *Trends Pharmacol Sci.* 2020;41(9):653–664.
14. Ullah I, Subbarao RB, Rho GJ. Human mesenchymal stem cells – current trends and future prospective. *Biosci Rep.* 2015;35(2):e00191.
15. Vasanthan J, Gurusamy N, Rajasingh S, et al. Role of Human Mesenchymal Stem Cells in Regenerative Therapy. *Cells.* 2020;10(1):54.

PromoCell GmbH
Sickingenstr. 63/65
69126 Heidelberg
Germany

USA/Canada
Phone: 1 – 866 – 251 – 2860 (toll free)
Fax: 1 – 866 – 827 – 9219 (toll free)

Deutschland
Telefon: 0800 – 776 66 23 (gebührenfrei)
Fax: 0800 – 100 83 06 (gebührenfrei)

France
Téléphone: 0800 – 90 93 32 (ligne verte)
Téléfax: 0800 – 90 27 36 (ligne verte)

United Kingdom
Phone: 0800 96 03 33 (toll free)
Fax: 0800 169 85 54 (toll free)

Other Countries
Phone: +49 6221 – 649 34 0
Fax: +49 6221 – 649 34 40

info@promocell.com
www.promocell.com

© PromoCell GmbH